

Threading

TTP Series

TTP

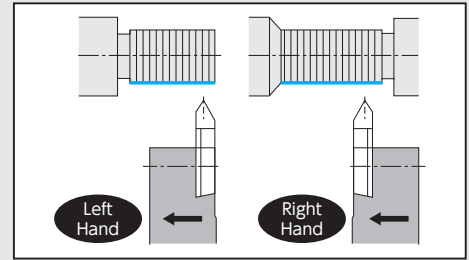
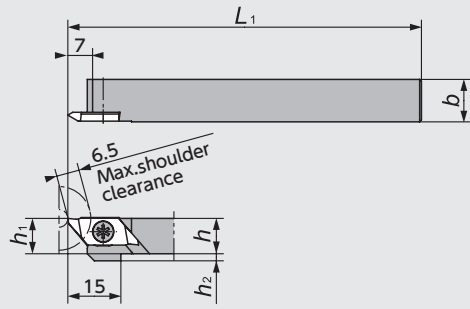

● Right-Hand style shown

Figure-1

TTP-OH2

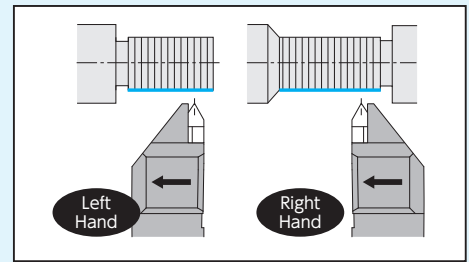
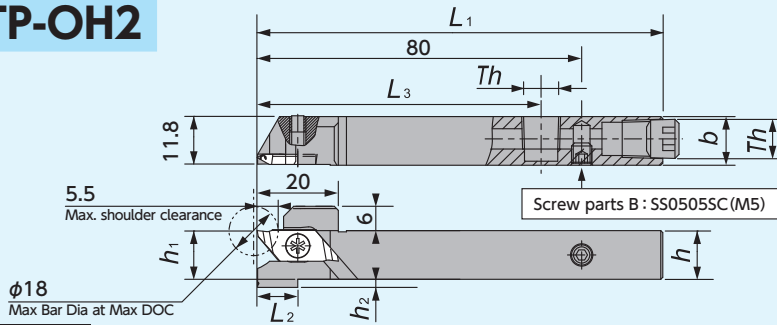

Th(screw parts [A])
1212/1616size : SPR1/8(Rc1/8)

● Right-Hand style shown

Figure-2

TTP-F

Shift Holder

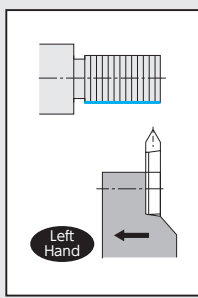
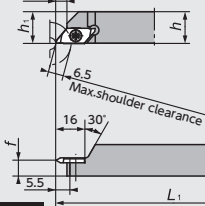

● Left-Hand style shown

Figure-3

TTP

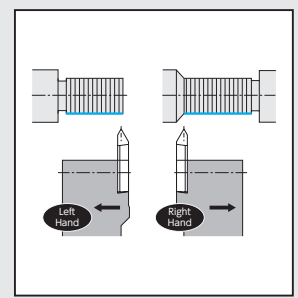
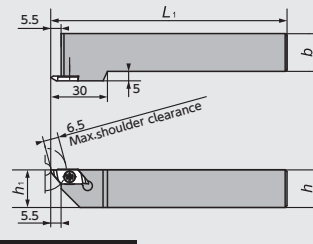

● Right-Hand style shown

Figure-4

DS-TTP

(DS Holder)

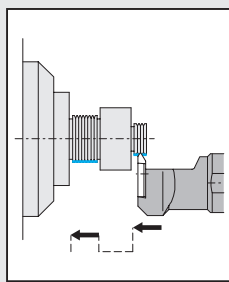
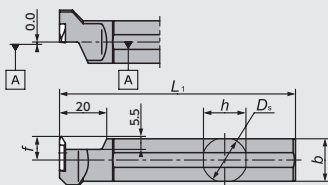

● Left-Hand style shown
☆ Takes Right-hand insert

Figure-5

CH-TTP

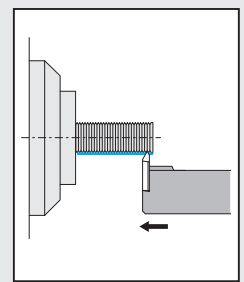
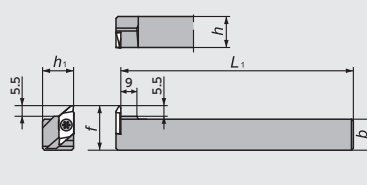

● Left-Hand style shown
☆ Takes Right-hand insert



Figure-6

TTP Series - Toolholders

Figure	Code No.		Item Number	Stock		Dimensions (mm)						Gage insert	Spare Parts			
	R	L		R	L	D _s	h	b	L ₁	h ₁	f		h ₂	Clamp Screw	Wrench	
1	5146238	5146220	TTP L08	●	●	-	8	10	120	8	-	0	TTP I 13	 (A) LRIS-4*10PW (A) (B) LRIS-4*12PW (A) (B) LRIS-4*10 (B)	 (A) CLR-15S (A) (B) LLR-25S-20*65 (B)	
	5145693	5145685	10	●	●		10	10	120	10						2
	5459854	5503024	12GX	●	●		12	12	85	12						0
	5145701	5145719	12	●	●		120	12								
	5459862	5459870	16H	●	●		16	16	100	16						
	5191234	5267190	16	●	●		120	16								
5459573	5459581	20F	●	●	20	20	80	20								











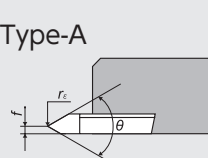

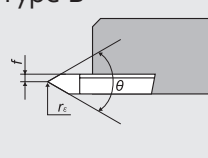
※Compatible with 16mm / 22mm round shank DS Series holders. DS-Sleeve G103

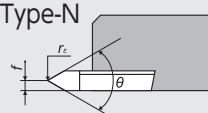
TTP Series - Toolholders

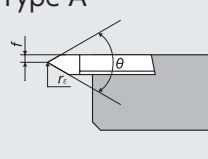
Figure	Code No.		Item Number	Stock		Dimensions (mm)								Gage insert 	Spare Parts		
	R	L		R	L	D _s	h	b	L ₁	h ₁	f	h ₂	L ₂		L ₃	Clamp Screw 	Wrench 
2	5061882	5061890	TTP^{R/L}12H-OH2	●	●	—	12	12	100	12	—	2	10	70	TTP I 13	LRIS-4*12PW	CLR-15S
	5062229	5062237	TTP^{R/L}16X-OH2	●	●	—	16	16	120	16	—	0	—	70			
3	5978150		TTPL12-F06		●	—	12	12	120	12	6	—	—	—	TTP I 13	LRIS-4*6 (B)	LLR-25S (B)
	5978168		TTPL16-F08		●	—	16	16	120	16	8	—	—	—			
4	5989959	5989942	TTP^{R/L}20K-25	●	●	—	20	20	125	20	—	—	—	—	TTP I 13	LRIS-4*10 (B)	LLR-25S (B)
	5989975	5989967	TTP^{R/L}25M-30	●	●	—	25	25	150	25	—	—	—	—			
5	5782149		DS-TTP^{R/L}16F*		●	16.00	15	15	80	—	10.0	—	—	TTP I 13	LRIS-4*10 (B)	LLR-25S-20*65 (B)	
	5278270		19		●	19.05	18	18	120								
	5278296		20		●	20.00	19	19									
	5324033		22*		●	22.00	21	21									
	5830641		25MET		●	25.00	24	24									150
	5317151		25		●	25.40	24	24									150
6	5885090		CH-TTP^{R/L}16		●	—	16	16	120	16	23	—	—	TTP I 13	LRIS-4*10 (B)	LLR-25S (B)	
	5885108		20		●	—	20	20	20	27	—	—	—				

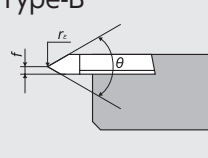
*Compatible with 16mm / 22mm round shank DS Series holders. DS-Sleeve  **G103**

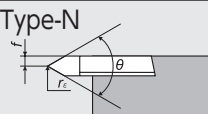
TTP Series - Inserts

Shape	Item Number	Dimensions (mm)			Thread Type		Carbide		PVD Coated Carbide													
		θ	f	r _e	Pitch	TPI	KM1	Stock	ZM3	Stock	QM3	Stock										
Right-Hand 	TTP60FR2A	60°	0.2	(0.05) MAX Flat	0.2~0.35	—	—	—	5892278	●	—	—										
	60FR4A																					
	60FR4AS 		0.4	0.2~0.75	—	—	—	5578158	●	—	—	—										
	60FR8A																					
	60FR8AS 	0.8	(R0.05)	0.4~1.25	—	—	5578117	●	—	—	—											
	TTP55FR8A											55°	—	—	—	—	—	5145495	●	—	—	
	Type-B 	TTP60FR2B	60°	0.2	(0.05) MAX Flat	0.2~0.35	—	—	—	5892302	●	—	—									
		60FR4B																				
		60FR4BS 		0.4	0.2~0.75	—	—	—	5578133	●	—	—	—									
		60FR8B																				
		60FR8BS 	0.8	(R0.05)	0.4~1.25	—	—	5578091	●	—	—	—										
		TTP55FR8B											55°	—	—	—	—	—	5145487	●	—	—
Type-N 	TTP60FR-N	60°	1.25	(R0.1)	1.0~1.5	—	—	—	5145560	●	—	5474630	●									
	60FR-NS 													(R0.2)	1.5~2.0	—	—	—	5578067	●	—	—
	60FR-N02																					
Left-Hand 	TTP60FL2A	60°	0.2	(0.05) MAX Flat	0.2~0.35	—	—	—	5892286	●	—	—										
	60FL4A																					
	60FL4AS 		0.4	0.2~0.75	—	—	—	5578174	●	—	—	—										
	60FL8A																					
	60FL8AS 	0.8	(R0.05)	0.4~1.25	—	—	5578125	●	—	—	—											
	TTP55FL8A											55°	—	—	—	—	—	5145503	●	—	—	
	Type-B 	TTP60FL2B	60°	0.2	(0.05) MAX Flat	0.2~0.35	—	—	—	5912555	●	—	—									
		60FL4B																				
		60FL4BS 		0.4	0.2~0.75	—	—	—	5578141	●	—	—	—									
		60FL8B																				
		60FL8BS 	0.8	(R0.05)	0.4~1.25	—	—	5578109	●	—	—	—										
		TTP55FL8B											55°	—	—	—	—	—	5145479	●	—	—
Type-N 	TTP60FL-N	60°	1.25	(R0.1)	1.0~1.5	—	—	—	5145552	●	—	5601265	●									
	60FL-NS 													(R0.2)	1.5~2.0	—	—	—	5578083	●	—	—
	60FL-N02																					