

SPLASH SERIES

Coolant Through Holders | For Swiss CNC Lathes

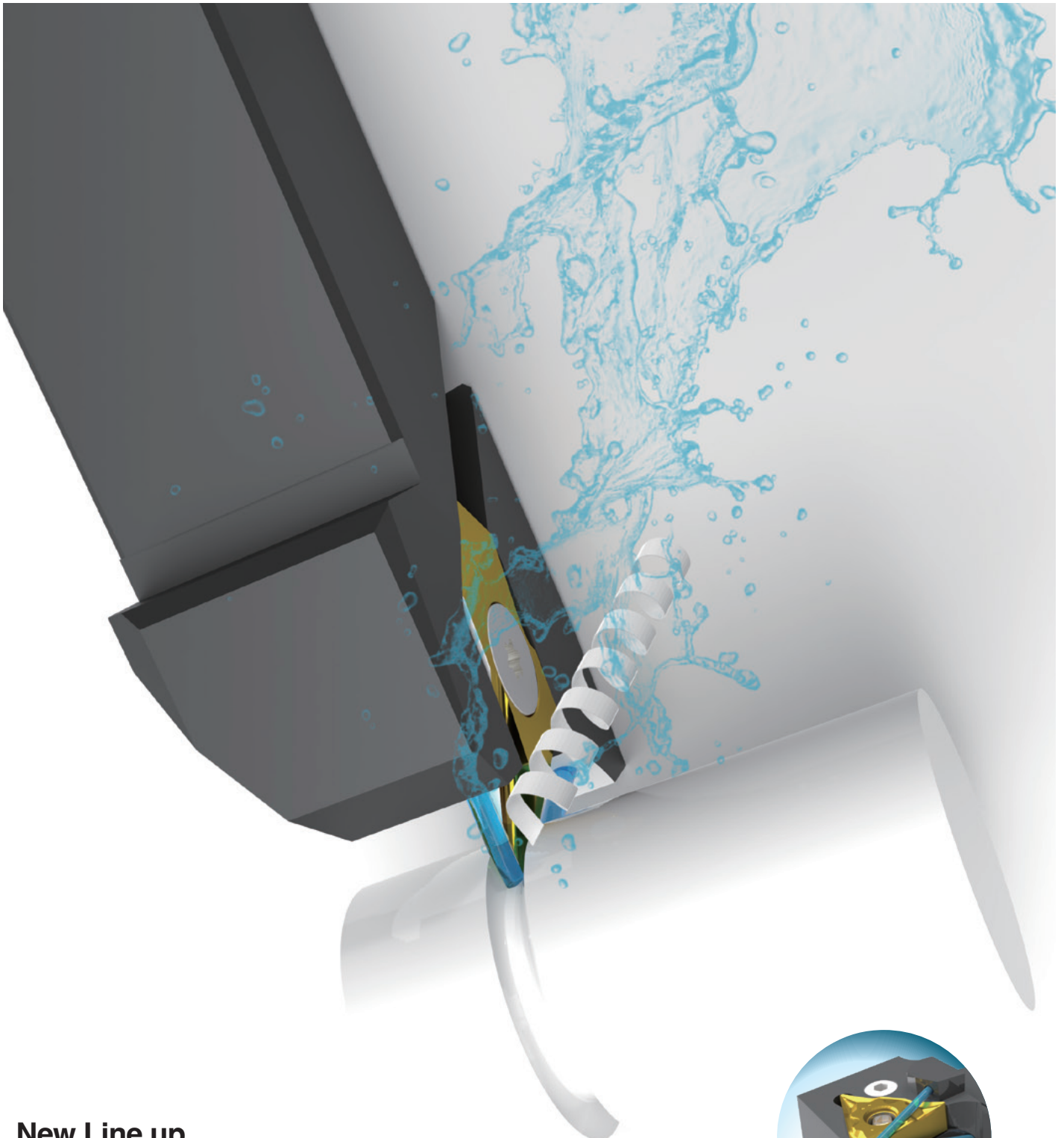

New Line up

" PTXNR type" for negative triangle inserts

TNGG inserts with superior cost performance can be installed

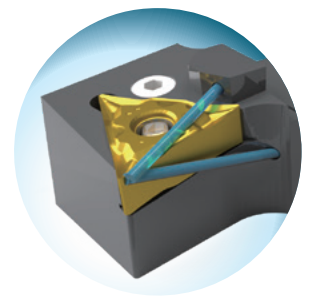

CERtainly | but not only | *CERamics*
Outstanding solutions for demanding applications



Solve chip issues with coolant focused on chip evacuation

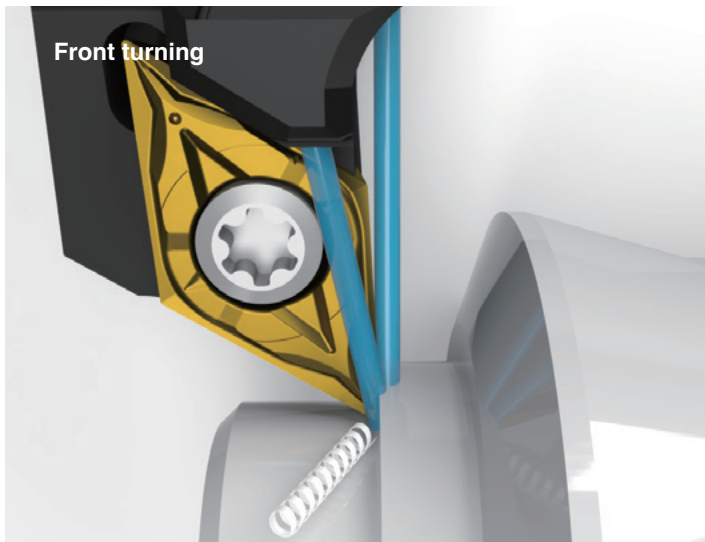

Front turning

Coolant flows from two locations (12mm and 16mm shank) to direct the chips away from the guide bushing.

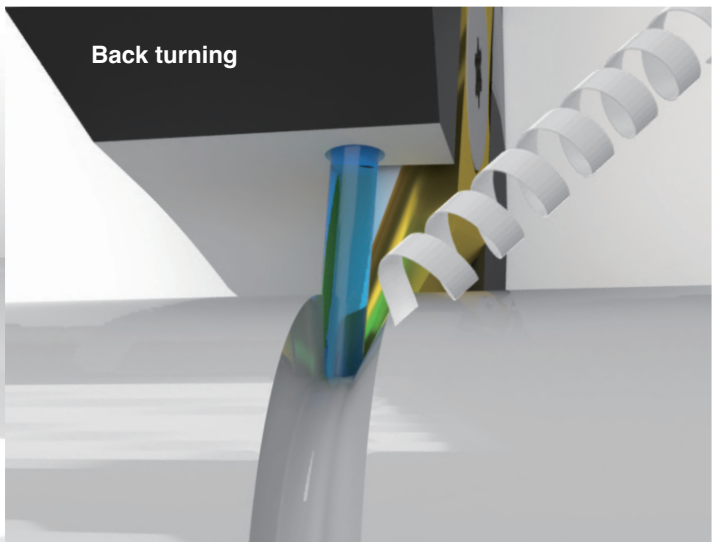

Back turning

By focusing coolant to the cutting edge, chips are flushed away from the machined surface to achieve an excellent surface finish.

SPLASH SERIES

Coolant Through Holders | For Swiss CNC Lathes

Utilizing coolant through tools eliminates chip issues and ensures stable machining

Effectively cools the cutting edge and extends tool life

Features

- Curling and breaking chips with coolant pressure
- Coolant is focused on the cutting edge to suppress heat and edge wear
- Variety of coolant connection options

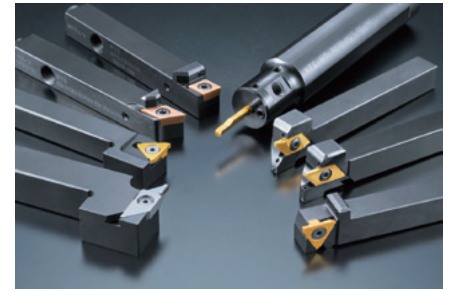

Tooling operations

Front turning / Back turning / Grooving / Threading / Cut-off / ID boring

Application	Type	Coolant hose connection	Coolant directly from tool post	Machine models with coolant directly from tool post	
Front turning Back turning Grooving Threading Cut-off ID boring	OH3	●	●	L12, L20, D25, M32	Citizen
				SB-16III, SD-26type S	STAR
				B026/32-III Series, BW269/329ZJ SS267/327-III, SS267/327-III-5AX SS207-III, SS207-III-5AX S205/206-II, S205A/206A-II	TSUGAMI
	OH2	●	●	L12, L20, D25, M32	Citizen
				SB-16III, SD-26 type S	STAR
	OH	●	-	-	-

*Based on information as of September 2023

Direct gang coolant connection "OH3"

OH3 Features

- New CTP-SUB cut-off holder lineup
- Lineup expansion of 16mm sq. shank tools with direct connect capability

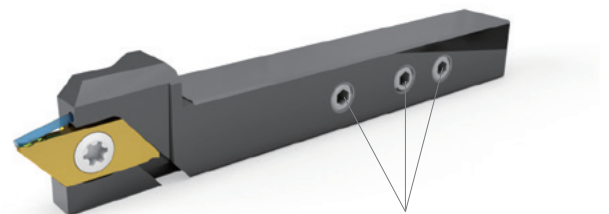

Direct Connect Toolholder Coolant Port

Coolant is supplied directly from the tool post to the tool

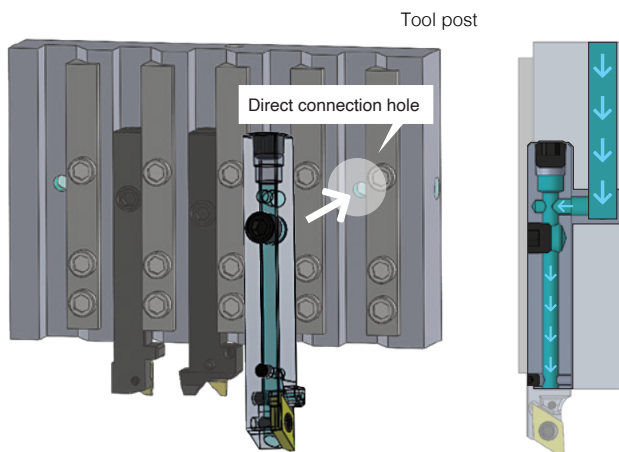

New

For negative triangle inserts
"PTXNR type"

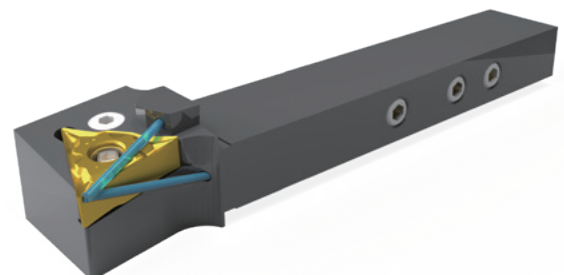

New OH3 tools make it possible to directly connect to a tool post through coolant system Also supports side and rear coolant hose connections

Reference Chart of OH3 Hole Position

*Based on information from September 2023

Make*	Model	Tool position**	Shank size	Overhang(mm)	Direct Connect Toolholder Coolant Port
Citizen	L12(2M)	T02 - T07	□10	17.5	B
		T01	□12	24.5	C
	M32(5M)	T01 - T05	□16	25.0	C
	D25	T10 - T13 , T30 - T32		30.0	A
	L20(2M/3M)	T01		30.0	A
STAR	SB-16III	T100 - T500 (T600)	□12	22.0	C
	SD-26 type S	T100	□16	30.0	
		T200 - T700		25.0	
TSUGAMI	B026/32-III Series	T05 - T09 , T11 - T15 , T26, T27	□16	26.0	B
	BW269/329ZJ	T05 - T09 , T26, T27			
	SS267/327-III SS267/327-III-5AX	T05 - T09 , T25 - T27			
	SS207-III, SS207-III-5AX	T05 - T10 , T26 - T28	□16(option)	26.0	A
	S205/206-II S205A/206A-II				

** The tool position varies depending on the option setting. Please confirm in advance.

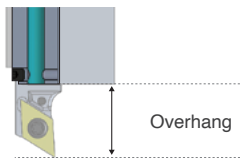

Compatible with various coolant hose connections (OH, OH2, OH3)

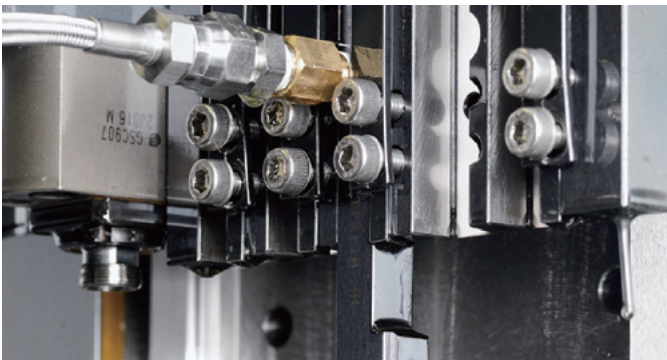

Side connection

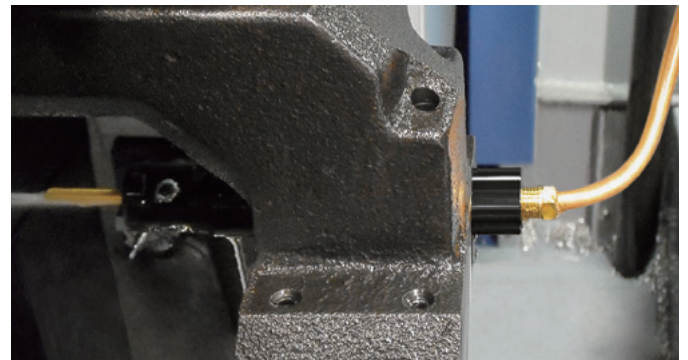

Rear connection

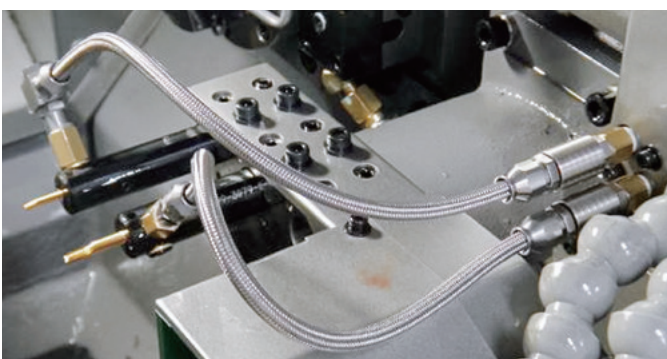



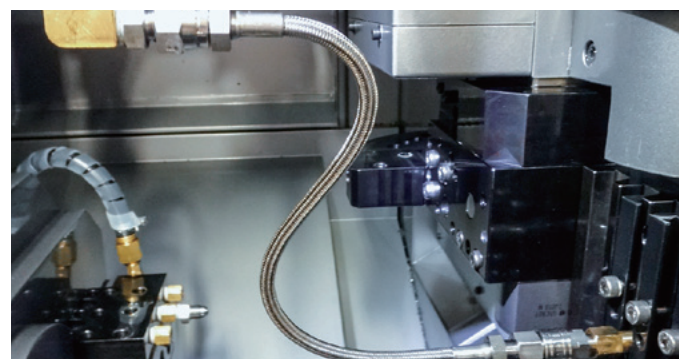

I.D. toolholder with side connection



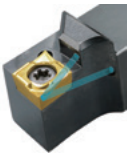

Hose mounting example (vertical tool post)

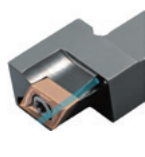
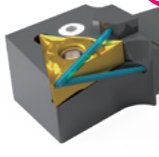
Product Lines

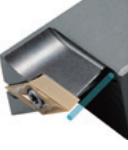
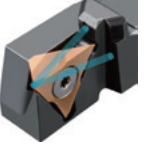
Front Turning → P6

Insert	CC..	DC..		TNGG16..
Holder	SCLC-OH2/OH	SDJC-OH2/OH	Y-SDJC-OH2/OH	PTXN-OH New
				
	VC..		TFX33../TF33..	
	SVJC-OH	Y-SVJC-OH	TFTR-OH	
				

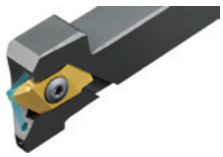
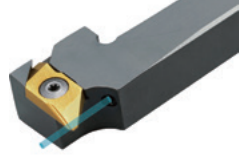
Back Turning → P14

Insert	TBP		TBPA
Holder	TBP-OH2/OH	Y-TBP-OH	TBPA-OH
			

Cut-off → P18

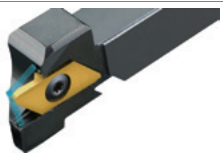
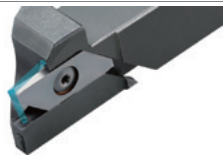
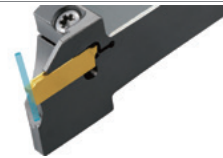
Insert	CTP	CTPA	CTDP
Holder	CTP-OH2/OH	CTPA-OH2/OH	CTDP-OH2/OH
			
Max. Cut-off Dia.	~φ12	~φ16	~φ25.4

Grooving / Side-Turning → P23

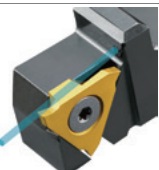
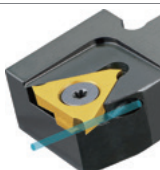
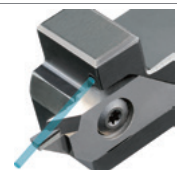
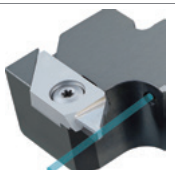
Insert	GTM..		GTPA..	
Holder	GTT-OH2/OH	Y-GTT-OH	GTPA-OH	Y-GTPA-OH
				

Threading → P26

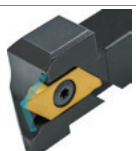
Insert	TTP
Holder	TTP-OH2
	

Information

- "-OH2" holder
When using the coolant lubrication method in which coolant is supplied to the cutting edge through the inside of the turret, remove CNT2 screw and set CNT screw to the side and rear of the holder.
- Use an Allen wrench 3.0(LW-3) for SS0605SC and an Allen wrench 5.0(LW-5) for SPR1/8.
- Use the included hex key 2.5(LW-2.5) for CNT2 screw (SS0505SC).

Front Turning Operations

TF.. series/Toolholder

TFT-OH3 Direct connect coolant port 3-hole type The Front Max.

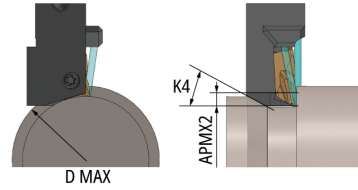
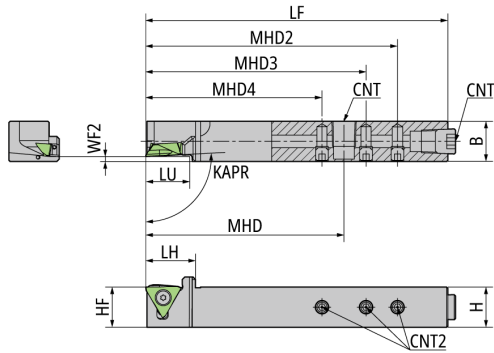

[Workpiece shape restrictions during machining]
 DMAX: Max. bar stock diameter during APMX2 max DOC
 K4: Max. taper angle
 APMX2: Max depth of cut

● Diagram shows right-hand tool

EDP	Item Number	Stock	Hand	DMAX mm	APMX2 mm	K4 °	B mm	CNT	CNT2	H mm	HF mm	KAPR °	LF mm	LH mm	LU mm	MHD mm	MHD2 mm	MHD3 mm	MHD4 mm	WF2 mm	Insert Gage
5121801	TFTR1616X-OH3	●	R	40	2.5	30	16	Rc1/8	M5	16	16	93	120	19.75	18	78.75	100	87.5	70	2	TFX33.. TF33..

For more information on the inserts, please reference 2023/2024 General Catalog Page Q8.

Spare Parts

Item Number	Clamp screw	Screw (for CNT)	Screw (for CNT2)	Wrench (for Clamp screw)	Wrench (for CNT2)
TFTR1616X-OH3	LR-S-4*10PW	SPR1/8L	SS0505SC	CLR-15S	LW-2.5

TFT-OH2 Direct connect coolant port 1-hole type The Front Max.

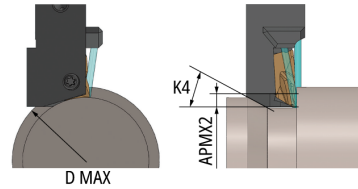
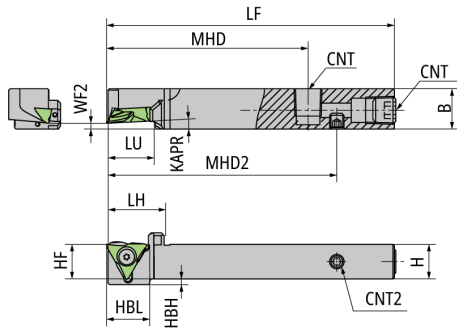

[Workpiece shape restrictions during machining]
 DMAX: Max. bar stock diameter during APMX2 max DOC
 K4: Max. taper angle
 APMX2: Max depth of cut

● Diagram shows right-hand tool

EDP	Item Number	Stock	Hand	DMAX mm	APMX2 mm	K4 °	B mm	CNT	CNT2	H mm	HBH mm	HBL mm	HF mm	KAPR °	LF mm	LH mm	LU mm	MHD mm	MHD2 mm	WF2 mm	Insert Gage
5030630	TFTR1014H-OH2	●	R	20	2.5	30	14	M6*1	M5	10	4	15	10	3	100	20	15	70	80	2	TFX33.. TF33..
5030648	TFTR1214H-OH2	●	R	30	2.5	30	14	Rc1/8	M5	12	2	15	12	3	100	20	15	70	80	2	TFX33.. TF33..
5030655	TFTR1616X-OH2	●	R	40	2.5	30	16	Rc1/8	M5	16	-	-	16	3	120	20	17.5	70	100	2	TFX33.. TF33..

For more information on the inserts, please reference 2023/2024 General Catalog Page Q8.

Spare Parts

Item Number	Clamp screw	Screw (for CNT)	Screw (for CNT2)	Wrench (for Clamp screw)	Wrench (for CNT2)
TFTR1014H-OH2	LR-S-4*10PW	SS0605SC	SS0505SC	CLR-15S	LW-2.5
TFTR1214H-OH2	LR-S-4*10PW	SPR1/8	SS0505SC	CLR-15S	LW-2.5
TFTR1616X-OH2	LR-S-4*10PW	SPR1/8L	SS0505SC	CLR-15S	LW-2.5

TN.. series/Toolholders

PTXN-OH3 Direct connect coolant port 3-hole type

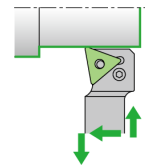
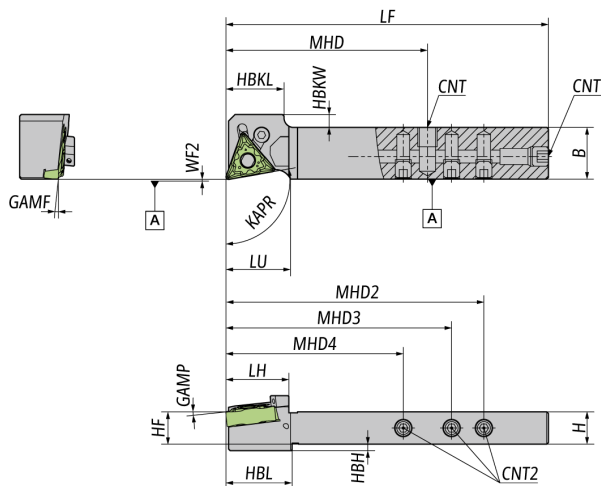

· Diagram shows right-hand tool

EDP	Item Number	Stock Hand	B mm	CNT	CNT2	GAMF °	GMAP °	H mm	HBH mm	HBKL mm	HBKW mm	HBL mm	HF mm	KAPR °	LF mm	LH mm	LU mm	MHD mm	MHD2 mm	MHD3 mm	MHD4 mm	WF2 mm	Insert Gage	
5128939	PTXNR1016X33N-OH3		R	16	M6*1	M5	6	6	10	2	18	4	20.5	10	100	100	19.5	20	62.5	80	70	55	0	TN..1604..
5129374	PTXNR1616X33N-OH3		R	16	Rc1/8	M5	6	6	16	-	18	4	-	16	100	120	19.5	20	78.75	100	87.5	70	0	TN..1604..

For more information on the inserts,
please reference 2023/2024 General Catalog Page Q8.

Spare Parts

Item Number	Clamp screw	Clamp Pin	Screw (for CNT)	Screw (for CNT2)	Wrench (for Clamp screw)
PTXNR1016X33N-OH3	LCS33	LCL33N	SS0605SC	SS0505SC	LW-2.5
PTXNR1616X33N-OH3	LCS33	LCL33N	SPR1/8	SS0505SC	LW-2.5

PTXN-OH2 Direct connect coolant port 1-hole type

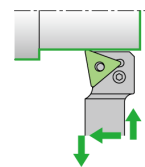
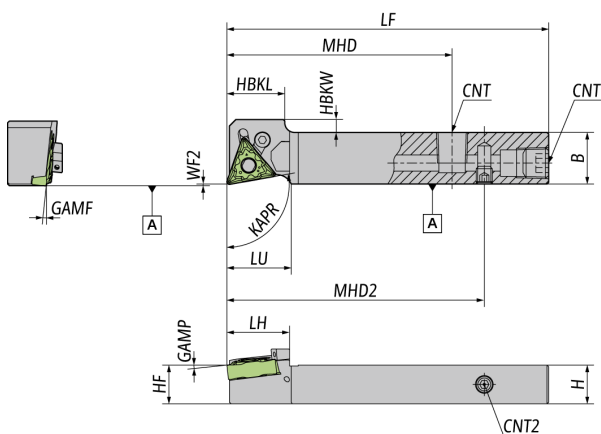

· Diagram shows right-hand tool

EDP	Item Number	Stock Hand	B mm	CNT	CNT2	GAMF °	GMAP °	H mm	HBKL mm	HBKW mm	HF mm	KAPR °	LF mm	LH mm	LU mm	MHD mm	MHD2 mm	WF2 mm	Insert Gage	
5129309	PTXNR1216X33N-OH2		R	16	Rc1/8	M5	6	6	12	18	4	12	100	100	19.5	20	70	80	0	TN..1604..

For more information on the inserts,
please reference 2023/2024 General Catalog Page Q8.

Spare Parts

Item Number	Clamp screw	Clamp Pin	Screw (for CNT)	Screw (for CNT2)	Wrench (for Clamp screw)
PTXNR1216X33N-OH2	LCS33	LCL33N	SPR1/8	SS0505SC	LW-2.5

CC.. Series/Toolholder

SCLC-N-OH3 Direct connect coolant port 3-hole type

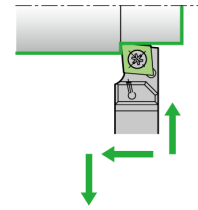
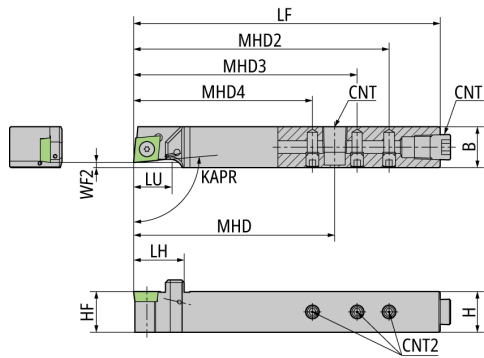

● Diagram shows right-hand tool

EDP	Item Number	Stock	Hand	B mm	CNT	CNT2	H mm	HF mm	KAPR °	LF mm	LH mm	LU mm	MHD mm	MHD2 mm	MHD3 mm	MHD4 mm	WF2 mm	Insert Gage
5123468	SCLCR1012H09N-OH3	●	R	12	M6*1	M5	10	10	95	100	17	12	62.5	80	70	55	0	CC.09T3..
5121819	SCLCR1616X09N-F02OH3	●	R	16	Rc1/8	M5	16	16	95	120	20	17.7	78.75	100	87.5	70	2	CC.09T3..

For more information on the inserts, please reference 2023/2024 General Catalog Page Q8.

Spare Parts

Item Number	Clamp screw	Screw (for CNT)	Screw (for CNT2)	Wrench (for Clamp screw)	Wrench (for CNT2)
SCLCR1012H09N-OH3	LRIS-4*10	SS0605SC	SS0505SC	LLR-25S	LW-2.5
SCLCR1616X09N-F02OH3	LRIS-4*10	SPR1/8	SS0505SC	LLR-25S	LW-2.5

SCLC-N-OH2 Direct connect coolant port 1-hole type

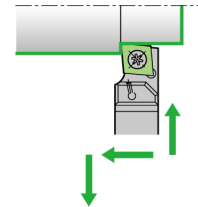
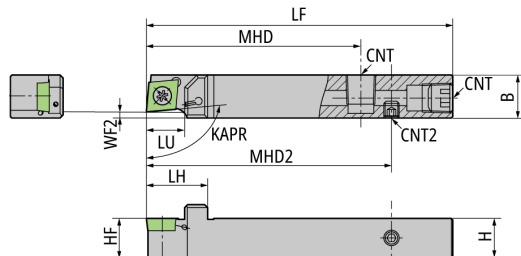

● Diagram shows right-hand tool

EDP	Item Number	Stock	Hand	B mm	CNT	CNT2	H mm	HF mm	KAPR °	LF mm	LH mm	LU mm	MHD mm	MHD2 mm	WF2 mm	Insert Gage
5037957	SCLCR1214H09N-F02OH2	●	R	14	Rc1/8	M5	12	12	95	100	19.5	12	70	80	2	CC.09T3..
5044011	SCLCR1616X09N-F02OH2	●	R	16	Rc1/8	M5	16	16	95	120	19.5	17.7	70	100	2	CC.09T3..

For more information on the inserts, please reference 2023/2024 General Catalog Page Q8.

Spare Parts

Item Number	Clamp screw	Screw (for CNT)	Screw (for CNT2)	Wrench (for Clamp screw)	Wrench (for CNT2)
SCLCR1214H09N-F02OH2	LRIS-4*10	SPR1/8	SS0505SC	LLR-25S	LW-2.5
SCLCR1616X09N-F02OH2	LRIS-4*10	SPR1/8	SS0505SC	LLR-25S	LW-2.5

SCLC-N-OH Coolant hose connection type

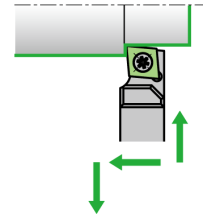
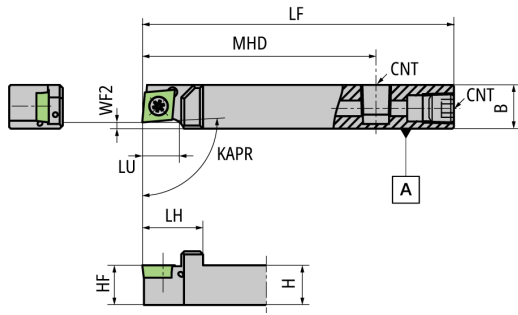

● Diagram shows right-hand tool

EDP	Item Number	Stock	Hand	B mm	CNT	H	HF mm	KAPR mm	LF °	LH mm	LU mm	MHD mm	WF2 mm	Insert Gage
5905740	SCLCR1014F09N-F02OH	● ●	R	14	M6*1	10	10	95	80	19.5	12	55	2	CC..09T3..
5905732	SCLCR1214H09N-F02OH	● ●	R	14	Rc1/8	12	12	95	100	19.5	12	75	2	CC..09T3..
5905658	SCLCR1616H09N-F02OH	● ●	R	16	Rc1/8	16	16	95	100	19.5	17.7	75	2	CC..09T3..

*For more information on the inserts,
please reference 2023/2024 General Catalog Page Q8.*

Spare Parts

Item Number	Clamp screw	Screw (for CNT)	Wrench (for Clamp screw)	Wrench (for CNT)
SCLCR1014F09N-F02OH	LRIS-4*10	SS0605SC	LLR-25S	LW-3
SCLCR1214H09N-F02OH	LRIS-4*10	SPR1/8	LLR-25S	-
SCLCR1616H09N-F02OH	LRIS-4*10	SPR1/8	LLR-25S	-

DC.. Series/Toolholder

SDJC-N-OH3 Direct connect coolant port 3-hole type

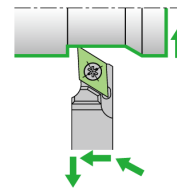
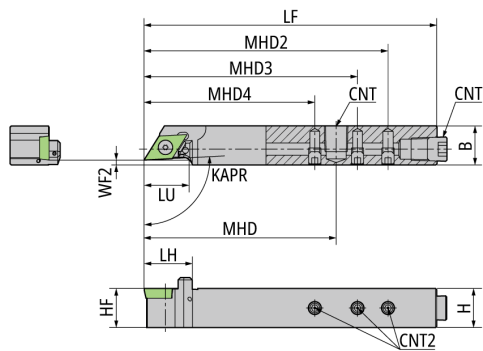

● Diagram shows right-hand tool

EDP	Item Number	Stock	Hand	B mm	CNT	CNT2	H mm	HF mm	KAPR °	LF mm	LH mm	LU mm	MHD mm	MHD2 mm	MHD3 mm	MHD4 mm	WF2 mm	Insert Gage	
5117767	SDJCR1012H11N-OH3		R	12	M6*1	M5	10	10	93	100	17	16	62.5	80	70	55	0	DC..11T3..	DC..11T3..WP(TFD11..)
5122353	SDJCR1616X11N-F02OH3		R	16	Rc1/8	M5	16	16	93	120	20	18.4	78.75	100	87.5	70	2	DC..11T3..	DC..11T3..WP(TFD11..)

For more information on the inserts, please reference 2023/2024 General Catalog Page Q8.

Spare Parts

Item Number	Clamp screw	Screw (for CNT)	Screw (for CNT2)	Wrench (for Clamp screw)	Wrench (for CNT2)
SDJCR1012H11N-OH3	LRIS-4*10	SS0605SC	SS0505SC	LLR-25S	LW-2.5
SDJCR1616X11N-F02OH3	LRIS-4*10	SPR1/8	SS0505SC	LLR-25S	LW-2.5

SDJC-N-OH2 Direct connect coolant port 1-hole type

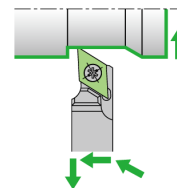
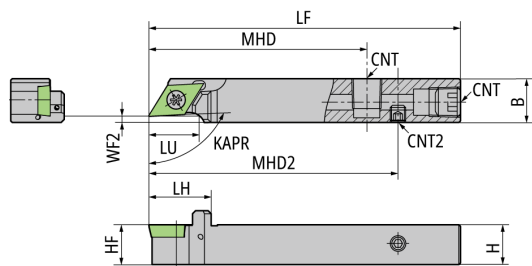

● Diagram shows right-hand tool

EDP	Item Number	Stock	Hand	B mm	CNT	CNT2	H mm	HF mm	KAPR °	LF mm	LH mm	LU mm	MHD mm	MHD2 mm	WF2 mm	Insert Gage	
5034871	SDJCR1214H11N-F02OH2		R	14	Rc1/8	M5	12	12	93	100	19.5	16	70	80	2	DC..11T3..	DC..11T3..WP(TFD11..)
5044029	SDJCR1616X11N-F02OH2		R	16	Rc1/8	M5	16	16	93	120	19.5	18.4	70	100	2	DC..11T3..	DC..11T3..WP(TFD11..)

For more information on the inserts, please reference 2023/2024 General Catalog Page Q8.

Spare Parts

Item Number	Clamp screw	Screw (for CNT)	Screw (for CNT2)	Wrench (for Clamp screw)	Wrench (for CNT2)
SDJCR1214H11N-F02OH2	LRIS-4*10	SPR1/8	SS0505SC	LLR-25S	LW-2.5
SDJCR1616X11N-F02OH2	LRIS-4*10	SPNPT1/8L	SS0505SC	LLR-25S	LW-2.5

SDJC-N-OH Coolant hose connection type

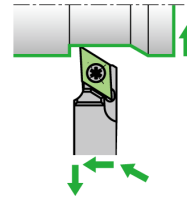
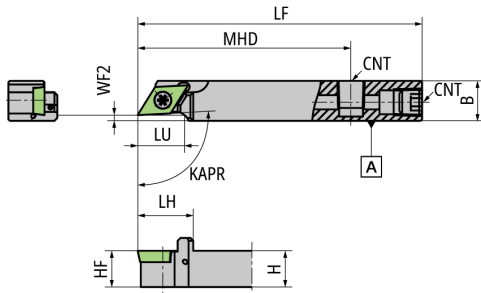

● Diagram shows right-hand tool

EDP	Item Number	Stock	Hand	B mm	CNT	H mm	HF mm	KAPR °	LF mm	LH mm	LU mm	MHD mm	WF2 mm	Insert Gage
5903208	SDJCR1014F11N-F02OH	●	R	14	M6*1	10	10	93	80	19.5	16	55	2	DC..11T3.. DC..11T3..WP(TFD11..)
5886254	SDJCR1214H11N-F02OH	●	R	14	Rc1/8	12	12	93	100	19.5	16	75	2	DC..11T3.. DC..11T3..WP(TFD11..)
5903216	SDJCR1616H11N-F02OH	●	R	16	Rc1/8	16	16	93	100	19.5	18.4	75	2	DC..11T3.. DC..11T3..WP(TFD11..)

For more information on the inserts, please reference 2023/2024 General Catalog Page Q8.

Spare Parts

Item Number	Clamp screw	Screw (for CNT)	Wrench (for Clamp screw)	Wrench (for CNT)
SDJCR1014F11N-F02OH	LRIS-4*10	SS06055C	LLR-25S	LW-3
SDJCR1214H11N-F02OH	LRIS-4*10	SPR1/8	LLR-25S	-
SDJCR1616H11N-F02OH	LRIS-4*10	SPR1/8	LLR-25S	-

Y-SDJC-N-OH2 Direct connect coolant port 1-hole type Y-axis

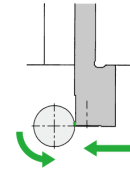
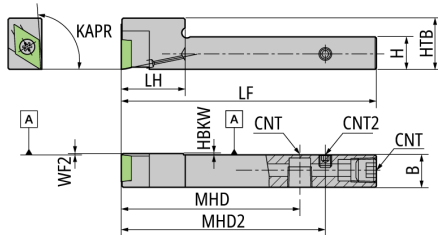

● Diagram shows right-hand tool
NOTE: Use a right-handed (R) or non-handed insert.

EDP	Item Number	Stock	Hand	B mm	CNT	CNT2	H mm	HBKW mm	HTB mm	KAPR °	LF mm	LH mm	MHD mm	MHD2 mm	WF2 mm	Insert Gage
5035209	Y-SDJCR1212H11S-OH2	●	R	12	Rc1/8	M5	12	0.5	20	93	100	20	70	80	0	DC..11T3.. DC..11T3..WP(TFD11..)

For more information on the inserts, please reference 2023/2024 General Catalog Page Q8.

Spare Parts

Item Number	Clamp screw	Screw (for CNT)	Screw (for CNT2)	Wrench (for Clamp screw)	Wrench (for CNT2)
Y-SDJCR1212H11S-OH2	LRIS-4*10	SPR1/8	SS05055C	LLR-25S-20*65	LW-2.5

Y-SDJC-N-OH Coolant hose connection type Y-axis

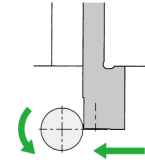
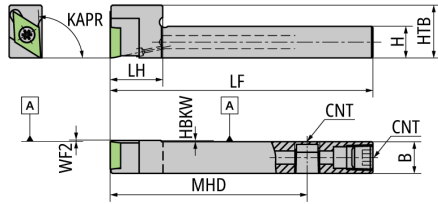

● Diagram shows right-hand tool

NOTE: Use a right-handed (R) or non-handed insert.

EDP	Item Number	Stock	Hand	B mm	CNT	H mm	HBKW mm	HTB mm	KAPR °	LF mm	LH mm	MHD mm	WF2 mm	Insert Gage	
5910575	Y-SDJCR1212H11S-OH	●	R	12	Rc1/8	12	0.5	20	93	100	20	75	0	DC..11T3..	DC..11T3..WP(TFD11..)
5910583	Y-SDJCR1616H11-OH	●	R	16	Rc1/8	16	0.5	20	93	100	25	75	0	DC..11T3..	DC..11T3..WP(TFD11..)

For more information on the inserts,
please reference 2023/2024 General Catalog Page Q8.

Spare Parts

Item Number	Clamp screw	Screw (for CNT)	Wrench (for Clamp screw)
Y-SDJCR1212H11S-OH	LRIS-4*10	SPR1/8	LLR-25S-20*65
Y-SDJCR1616H11-OH	LRIS-4*10	SPR1/8	LLR-25S-20*65

VC.. Series/Toolholder

SVJC-N-OH Coolant hose connection type

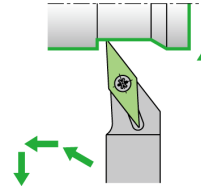
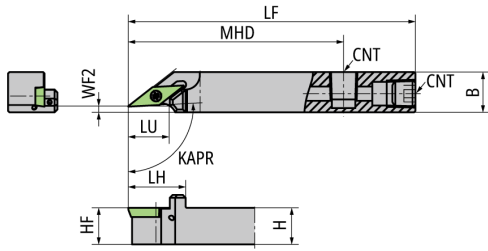

● Diagram shows right-hand tool

EDP	Item Number	Stock	Hand	B mm	CNT	H mm	HF mm	HTB mm	KAPR °	LF mm	LH mm	LU mm	MHD mm	WF2 mm	Insert Gage
5020482	SVJCR1014F11N-F02OH	●	R	14	M6*1	10	10	-	93	80	21	18	55	2	VC..1103.. VC..1103..WP(TFV11..)
5000419	SVJCR1214H11N-F02OH	●	R	14	Rc1/8	12	12	-	93	100	21	18	75	2	VC..1103.. VC..1103..WP(TFV11..)
5020508	SVJCR1616H11N-F02OH	●	R	16	Rc1/8	16	16	-	93	100	21	18	75	2	VC..1103.. VC..1103..WP(TFV11..)

For more information on the inserts, please reference 2023/2024 General Catalog Page Q8.

Spare Parts

Item Number	Clamp screw	Screw (for CNT)	Wrench (for Clamp screw)	Wrench (for CNT)
SVJCR1014F11N-F02OH	LRIS-2.5*7	SS0605SC	CLR-15S	LW-3
SVJCR1214H11N-F02OH	LRIS-2.5*7	SPR1/8	CLR-15S	-
SVJCR1616H11N-F02OH	LRIS-2.5*7	SPR1/8	CLR-15S	-

Y-SVJC-OH Coolant hose connection type Y-Axis

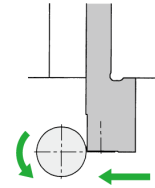
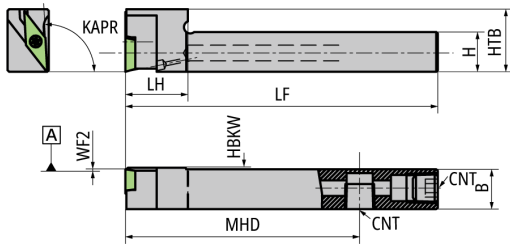

● Diagram shows right-hand tool

NOTE: Use a right-handed (R) or non-handed insert.

EDP	Item Number	Stock	Hand	B mm	CNT	H mm	HBKW mm	HTB mm	KAPR °	LF mm	LH mm	MHD mm	WF2 mm	Insert Gage
5021209	Y-SVJCR1212H11S-OH	●	R	12	Rc1/8	12	0.5	20	93	100	20	75	0	VC..1103.. VC..1103..WP(TFV11..)
5021191	Y-SVJCR1616H11S-OH	●	R	16	Rc1/8	16	0.5	20	93	100	20	75	0	VC..1103.. VC..1103..WP(TFV11..)

For more information on the inserts, please reference 2023/2024 General Catalog Page Q8.

Spare Parts

Item Number	Clamp screw	Screw (for CNT)	Wrench (for Clamp screw)
Y-SVJCR1212H11S-OH	LRIS-2.5*7	SPR1/8	CLR-15S
Y-SVJCR1616H11S-OH	LRIS-2.5*7	SPR1/8	CLR-15S

Back Turning Operations

TBP.. series/Toolholder

TBP-OH3 Direct connect coolant port 3-hole type

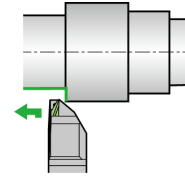
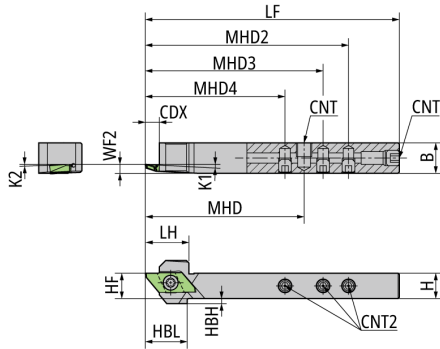

● Diagram shows right-hand tool

EDP	Item Number	Stock	Hand	B mm	CDX mm	CNT	CNT2	H mm	HBH mm	HBL mm	HF mm	K1 °	K2 °	LF mm	LH mm	MHD mm	MHD2 mm	MHD3 mm	MHD4 mm	WF2 mm	Insert Gage
5117759	TBPR1012H-OH3	●	R	12	5.5	M6*1	M5	10	2	16.5	10	3	2	100	17.33	62.5	80.18	70.18	55.18	3.5	TBP..
5121793	TBPR16X-OH3	●	R	16	5.5	Rc1/8	M5	16	-	-	16	3	2	120	20	78.75	100	87.5	70	3.5	TBP..

For more information on the inserts, please reference 2023/2024 General Catalog Page Q8.

Spare Parts

Item Number	Clamp screw	Screw (for CNT)	Screw (for CNT2)	Wrench (for Clamp screw)	Wrench (for CNT2)
TBPR1012H-OH3	LRIS-4*10PW	SS0605SC	SS0505SC	CLR-15S	LW-2.5
TBPR16X-OH3	LRIS-4*12PW	SPR1/8	SS0505SC	CLR-15S	LW-2.5

TBP-OH2 Direct connect coolant port 1-hole type

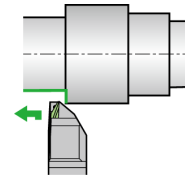
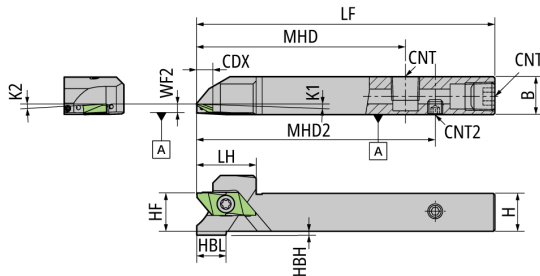

● Diagram shows right-hand tool

EDP	Item Number	Stock	Hand	B mm	CDX mm	CNT	CNT2	H mm	HBH mm	HBL mm	HF mm	K1 °	K2 °	LF mm	LH mm	MHD mm	MHD2 mm	WF2 mm	Insert Gage
5037965	TBPR12H-OH2	●	R	12	5.5	Rc1/8	M5	12	2	10	12	3	2	100	19.5	70	80	3.5	TBP..
5043971	TBPR16X-OH2	●	R	16	5.5	Rc1/8	M5	16	-	-	16	3	2	120	19.5	70	100	3.5	TBP..

For more information on the inserts, please reference 2023/2024 General Catalog Page Q8.

Spare Parts

Item Number	Clamp screw	Screw (for CNT)	Screw (for CNT2)	Wrench (for Clamp screw)	Wrench (for CNT2)
TBPR12H-OH2	LRIS-4*12PW	SPR1/8	SS0505SC	CLR-15S	LW-2.5
TBPR16X-OH2	LRIS-4*12PW	SPR1/8	SS0505SC	CLR-15S	LW-2.5

TBP-OH Coolant hose connection type

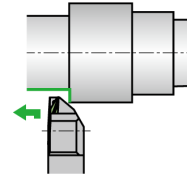
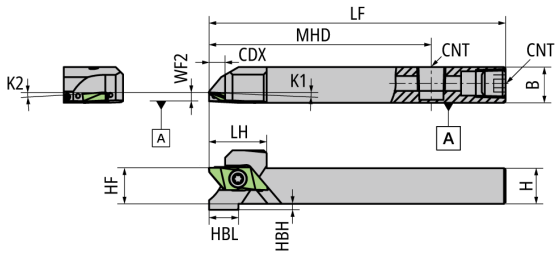

● Diagram shows right-hand tool

EDP	Item Number	Stock	Hand	B mm	CDX mm	CNT	H mm	HBH mm	HBL mm	HF mm	K1 °	K2 °	LF mm	MHD mm	WF2 mm	Insert Gage
5925722	TBPR1012H-OH	●	R	12	5.5	M6*1	10	4	19	10	3	2	100	75	3.5	TBP..
5925730	TBPR12H-OH	●	R	12	5.5	Rc1/8	12	2	10	12	3	2	100	75	3.5	TBP..
5925748	TBPR16H-OH	●	R	16	5.5	Rc1/8	16	-	-	16	3	2	100	75	3.5	TBP..

For more information on the inserts,
please reference 2023/2024 General Catalog Page Q8.

Spare Parts

Item Number	Clamp screw	Screw (for CNT)	Wrench (for Clamp screw)
TBPR1012H-OH	LRIS-4*10PW	SS0605SC	CLR-15S
TBPR12H-OH	LRIS-4*12PW	SPR1/8	CLR-15S
TBPR16H-OH	LRIS-4*12PW	SPR1/8	CLR-15S

Y-TBP-OH Coolant hose connection type Y-axis

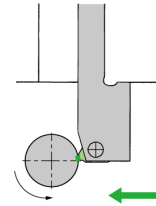
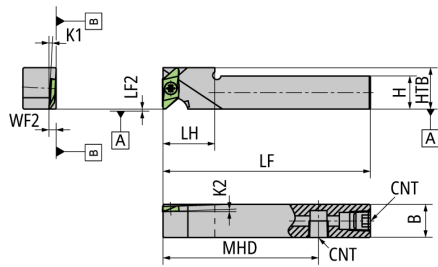

● Diagram shows right-hand tool

NOTE: Use a right-handed (R) or non-handed insert.

EDP	Item Number	Stock	Hand	B mm	CNT	H mm	HTB mm	K1 °	K2 °	LF mm	LF2 mm	LH mm	MHD mm	WF2 mm	Insert Gage
5911508	Y-TBPR12HS-OH	●	R	12	Rc1/8	12	20	3	2	100	0	20	75	3.5	TBP..
5911516	Y-TBPR16H-OH	●	R	16	Rc1/8	16	20	3	2	100	0	25	75	3.5	TBP..

For more information on the inserts,
please reference 2023/2024 General Catalog Page Q8.

Spare Parts

Item Number	Clamp screw	Screw (for CNT)	Wrench (for Clamp screw)
Y-TBPR12HS-OH	LRIS-4*12PW	SPR1/8	CLR-15S
Y-TBPR16H-OH	LRIS-4*12PW	SPR1/8	CLR-15S

TBPA.. series/Toolholder

TBPA-OH Coolant hose connection type

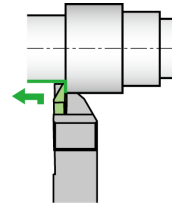
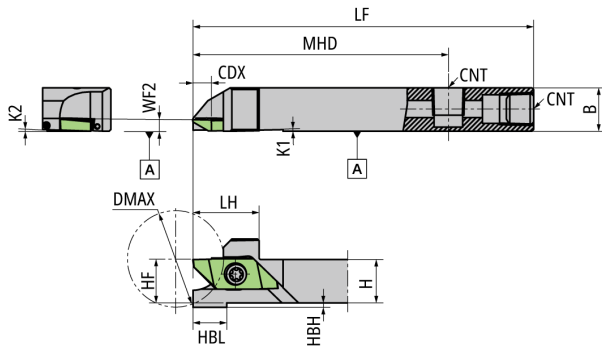

● Diagram shows right-hand tool

EDP	Item Number	Stock	Hand	DMAX mm	B mm	CDX mm	CNT	H mm	HBH mm	HBL mm	HF mm	K1 °	K2 °	LF mm	LH mm	MHD mm	WF2 mm	Insert Gage
5932983	TBPAR12H-OH	●	R	25	12	6.8	Rc1/8	12	4	10	12	1	2	100	19.5	75	(3.4)	TBPA..
5932991	TBPAR16H-OH	●	R	35	16	6.8	Rc1/8	16	2	10	16	1	2	100	19.5	75	(3.4)	TBPA..
5945811	TBPAR20H-OH	●	R	50	20	6.8	Rc1/8	20	-	-	20	1	2	100	19.5	75	(3.4)	TBPA..

For more information on the inserts, please reference 2023/2024 General Catalog Page Q8.

Spare Parts

Item Number	Clamp screw	Screw (for CNT)	Wrench (for Clamp screw)
TBPAR12H-OH	LRIS-4*12PW	SPR1/8	CLR-15S
TBPAR16H-OH	LRIS-4*12PW	SPR1/8	CLR-15S
TBPAR20H-OH	LRIS-4*12PW	SPR1/8	CLR-15S

CTPA-OH2 Direct connect coolant port 1-hole type

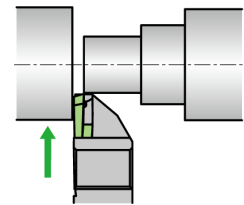
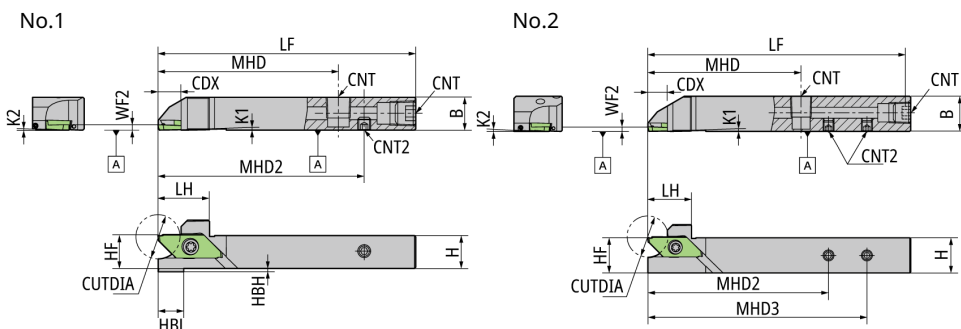

CTPAR/L16X-OH2

● Diagram shows right-hand tool

Figure	EDP	Item Number	Stock	Hand	CUTDIA mm	B mm	CNT	CNT2	H mm	HBH mm	HBL mm	HF mm	K1 °	K2 °	LF mm	LH mm	MHD mm	MHD2 mm	MHD3 mm	WF2 mm	Insert Gage
1	5037932	CTPAR12H-OH2	●	R	16	12	Rc1/8	M5	12	2	10	12	1	2	100	19.5	70	80	-	2	CTPA.. TBPA..
2	5043872	CTPAR16X-OH2	●	R	16	16	Rc1/8	M5	16	-	-	16	1	2	120	19.5	70	82.5	100	2	CTPA.. TBPA..
1	5037924	CTPAL12H-OH2	●	L	16	12	Rc1/8	M5	12	2	10	12	1	2	100	19.5	70	80	-	2	CTPA.. TBPA..
2	5043864	CTPAL16X-OH2	●	L	16	16	Rc1/8	M5	16	-	-	16	1	2	120	19.5	70	82.5	100	2	CTPA.. TBPA..

For more information on the inserts, please reference 2023/2024 General Catalog Page Q8.

Spare Parts

Item Number	Clamp screw	Screw (for CNT)	Screw (for CNT2)	Wrench (for Clamp screw)	Wrench (for CNT2)
CTPAR12H-OH2	LRIS-4*12PW	SPR1/8	SS0505SC	CLR-15S	LW-2.5
CTPAR16X-OH2	LRIS-4*12PW	SPR1/8	SS0505SC	CLR-15S	LW-2.5
CTPAL12H-OH2	LRIS-4*12PW	SPR1/8	SS0505SC	CLR-15S	LW-2.5
CTPAL16X-OH2	LRIS-4*12PW	SPR1/8	SS0505SC	CLR-15S	LW-2.5

CTPA-OH Coolant hose connection type

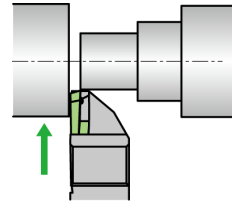
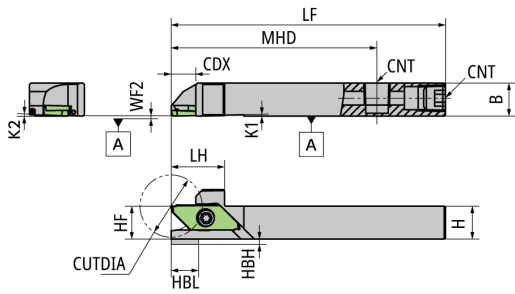

● Diagram shows right-hand tool

EDP	Item Number	Stock	Hand	CUTDIA mm	B mm	CNT	H mm	HBH mm	HBL mm	HF mm	K1 °	K2 °	LF mm	LH mm	MHD mm	WF2 mm	Insert Gage	
5931522	CTPAR12H-OH	●	R	16	12	Rc1/8	12	2	10	12	1	2	100	19.5	75	0	CTPA..	TBPA..
5931548	CTPAR16H-OH	●	R	16	16	Rc1/8	16	-	-	16	1	2	100	19.5	75	0	CTPA..	TBPA..
5931530	CTPAL12H-OH	●	L	16	12	Rc1/8	12	2	10	12	1	2	100	19.5	75	0	CTPA..	TBPA..
5931563	CTPAL16H-OH	●	L	16	16	Rc1/8	16	-	-	16	1	2	100	19.5	75	0	CTPA..	TBPA..

For more information on the inserts, please reference 2023/2024 General Catalog Page Q8.

Spare Parts

Item Number	Clamp screw	Wrench (for Clamp screw)
CTPAR12H-OH	LRIS-4*12PW	CLR-15S
CTPAR16H-OH	LRIS-4*12PW	CLR-15S
CTPAL12H-OH	LRIS-4*12PW	CLR-15S
CTPAL16H-OH	LRIS-4*12PW	CLR-15S

Cut-Off Operations

CTP.. series/Toolholder

CTP-OH2 Direct connect coolant port 1-hole type

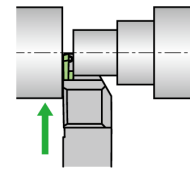
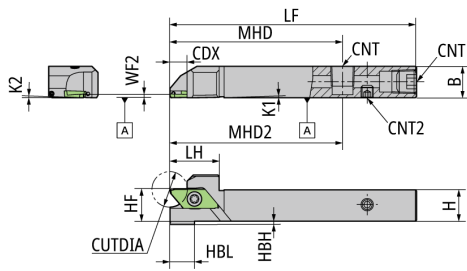

● Diagram shows right-hand tool

EDP	Item Number	Stock	Hand	CUTDIA mm	B mm	CDX mm	CNT	CNT2	H mm	HBH mm	HBL mm	HF mm	K1 °	K2 °	LF mm	LH mm	MHD mm	MHD2 mm	MHD3 mm	L8 mm	WF2 mm	Insert Gage	
5037874	CTPR12H-OH2	●	R	12	12	7	Rc1/8	M5	12	2	10	12	1	2	100	19.5	70	80	-	-	1.5	CTP.	-
5037866	CTPL12H-OH2	●	L	12	12	7	Rc1/8	M5	12	2	10	12	1	2	100	19.5	70	80	-	-	1.5	CTP.	-

For more information on the inserts, please reference 2023/2024 General Catalog Page Q8.

Spare Parts

Item Number	Clamp screw	Screw (for CNT)	Screw (for CNT2)	Wrench (for Clamp screw)	Wrench (for CNT2)
CTPR12H-OH2	LRIS-4*12PW	SPR1/8	SS0505SC	CLR-15S	LW-2.5
CTPL12H-OH2	LRIS-4*12PW	SPR1/8	SS0505SC	CLR-15S	LW-2.5

CTP-OH Coolant hose connection type

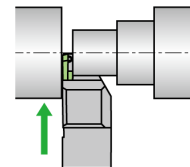
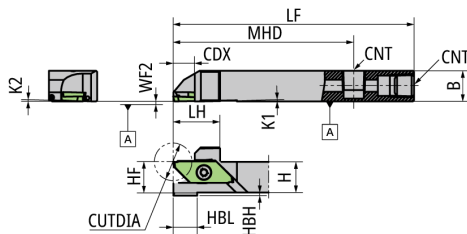

● Diagram shows right-hand tool

EDP	Item Number	Stock	Hand	CUTDIA mm	B mm	CDX mm	CNT	H mm	HBH mm	HBL mm	HF mm	K1 °	K2 °	LF mm	LH mm	MHD mm	WF2 mm	Insert Gage	
5921853	CTPR1012H-OH	●	R	12	12	7	M6*1	10	4	19	10	1	2	100	19.5	75	0	CTP.	-
5918651	CTPR12H-OH	●	R	12	12	7	Rc1/8	12	2	10	12	1	2	100	19.5	75	0	CTP.	-
5921879	CTPR16H-OH	●	R	12	16	7	Rc1/8	16	-	-	16	1	2	100	19.5	75	0	CTP.	-
5921861	CTPL1012H-OH	●	L	12	12	7	M6*1	10	4	19	10	1	2	100	19.5	75	0	CTP.	-
5918040	CTPL12H-OH	●	L	12	12	7	Rc1/8	12	2	10	12	1	2	100	19.5	75	0	CTP.	-
5921887	CTPL16H-OH	●	L	12	16	7	Rc1/8	16	-	-	16	1	2	100	19.5	75	0	CTP.	-

For more information on the inserts, please reference 2023/2024 General Catalog Page Q8.

Spare Parts

Item Number	Clamp screw	Screw (for CNT)	Wrench (for Clamp screw)	Wrench (for CNT)
CTPR1012H-OH	LRIS-4*12PW	SS0605SC	CLR-15S	LW-3
CTPR12H-OH	LRIS-4*12PW	SPR1/8	CLR-15S	-
CTPR16H-OH	LRIS-4*12PW	SPR1/8	CLR-15S	-
CTPL1012H-OH	LRIS-4*12PW	SS0605SC	CLR-15S	LW-3
CTPL12H-OH	LRIS-4*12PW	SPR1/8	CLR-15S	-
CTPL16H-OH	LRIS-4*12PW	SPR1/8	CLR-15S	-

CTPR-SUB-OH3 Direct connect coolant port 3-hole type for Sub-Spindle

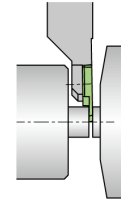
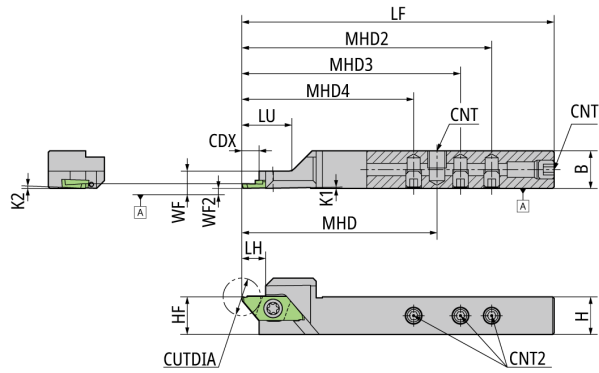

● Diagram shows right-hand tool

EDP	Item Number	Stock	Hand	CUTDIA mm	B mm	CDX mm	CNT	CNT2	H mm	HF mm	K1 °	K2 °	LF mm	LH mm	LU mm	MHD mm	MHD2 mm	MHD3 mm	MHD4 mm	WF mm	WF2 mm	Insert	Gage
5117809	CTPR12H-SUB-OH3	●	R	12	12	5.5	M6*1	M5	12	12	1	2	100	7.6	16	62.5	80	70	55	5.5	0	CTP..	-

For more information on the inserts, please reference 2023/2024 General Catalog Page Q8.

Spare Parts

Item Number	Clamp screw	Wrench (for Clamp screw)
CTPR12H-SUB-OH3	LRIS-4*5	LLR-25S

CTPL-SUB-OH3 Direct connect coolant port 3-hole type for Sub-Spindle

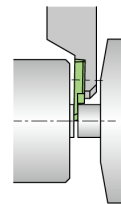
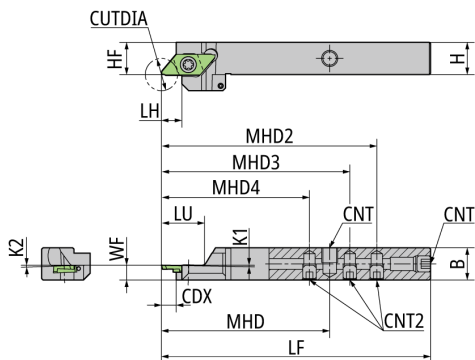

● Diagram shows left-hand tool

EDP	Item Number	Stock	Hand	CUTDIA mm	B mm	CDX mm	CNT	CNT2	H mm	HF mm	K1 °	K2 °	LF mm	LH mm	LU mm	MHD mm	MHD2 mm	MHD3 mm	MHD4 mm	WF mm	WF2 mm	Insert	Gage
5117783	CTPL12H-SUB-OH3	●	L	12	12	5.5	M6*1	M5	12	12	1	2	100	7.6	16	62.5	80	70	55	5.5	0	CTP..	-

For more information on the inserts, please reference 2023/2024 General Catalog Page Q8.

Spare Parts

Item Number	Clamp screw	Wrench (for Clamp screw)
CTPL12H-SUB-OH3	LRIS-4*5	LLR-25S

CTPA.. series/Toolholder

CTPA-OH2 Direct connect coolant port 1-hole type

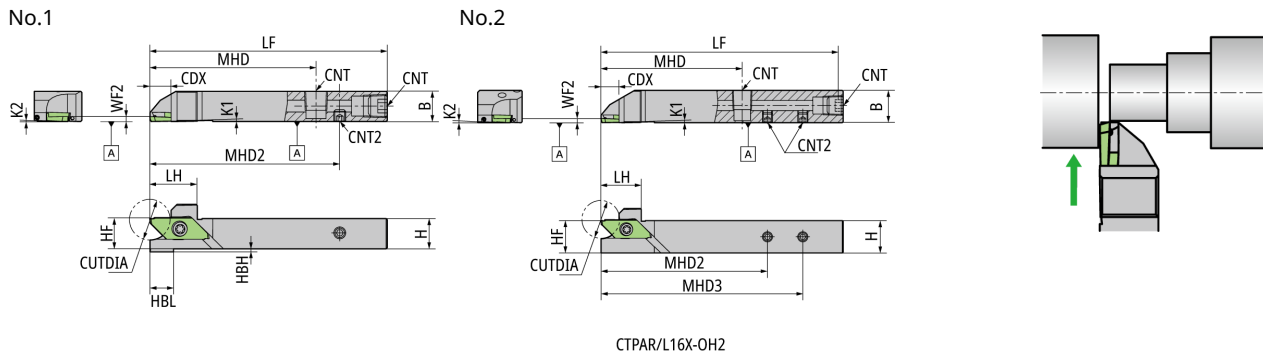

CTPAR/L16X-OH2

● Diagram shows right-hand tool

Figure	EDP	Item Number	Stock	Hand	CUTDIA mm	DMAX mm	B mm	CDX mm	CNT	CNT2	H mm	HBH mm	HBL mm	HF mm	K1 °	K2 °	LF mm	LH mm	MHD mm	MHD2 mm	MHD3 mm	WF2 mm	Insert Gage
1	5037932	CTPAR12H-OH2	●	R	16	16	12	9	Rc1/8	M5	12	2	10	12	1	2	100	19.5	70	80	-	2	CTPA.. TBPA..
2	5043872	CTPAR16X-OH2	●	R	16	16	16	9	Rc1/8	M5	16	-	-	16	1	2	120	19.5	70	82.5	100	2	CTPA.. TBPA..
1	5037924	CTPAL12H-OH2	●	L	16	16	12	9	Rc1/8	M5	12	2	10	12	1	2	100	19.5	70	80	-	2	CTPA.. TBPA..
2	5043864	CTPAL16X-OH2	●	L	16	16	16	9	Rc1/8	M5	16	-	-	16	1	2	120	19.5	70	82.5	100	2	CTPA.. TBPA..

For more information on the inserts, please reference 2023/2024 General Catalog Page Q8.

Spare Parts

Item Number	Clamp screw	Screw (for CNT)	Screw (for CNT2)	Wrench (for Clamp screw)	Wrench (for CNT2)
CTPAR12H-OH2	LRIS-4*12PW	SPR1/8	SS0505SC	CLR-15S	LW-2.5
CTPAR16X-OH2	LRIS-4*12PW	SPR1/8	SS0505SC	CLR-15S	LW-2.5
CTPAL12H-OH2	LRIS-4*12PW	SPR1/8	SS0505SC	CLR-15S	LW-2.5
CTPAL16X-OH2	LRIS-4*12PW	SPR1/8	SS0505SC	CLR-15S	LW-2.5

CTPA-OH Coolant hose connection type

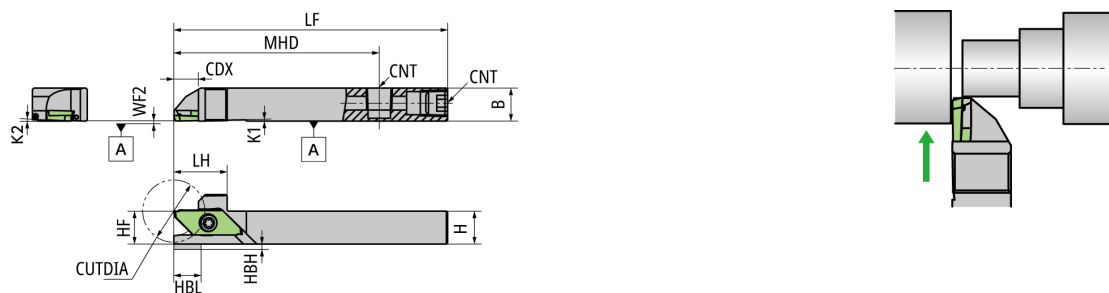

● Diagram shows right-hand tool

EDP	Item Number	Stock	Hand	CUTDIA mm	DMAX mm	B mm	CDX mm	CNT	H mm	HBH mm	HBL mm	HF mm	K1 °	K2 °	LF mm	LH mm	MHD mm	WF2 mm	Insert Gage
5931522	CTPAR12H-OH	●	R	16	16	12	9	Rc1/8	12	2	10	12	1	2	100	19.5	75	0	CTPA.. TBPA..
5931548	CTPAR16H-OH	●	R	16	16	16	9	Rc1/8	16	-	-	16	1	2	100	19.5	75	0	CTPA.. TBPA..
5931530	CTPAL12H-OH	●	L	16	16	12	9	Rc1/8	12	2	10	12	1	2	100	19.5	75	0	CTPA.. TBPA..
5931563	CTPAL16H-OH	●	L	16	16	16	9	Rc1/8	16	-	-	16	1	2	100	19.5	75	0	CTPA.. TBPA..

For more information on the inserts, please reference 2023/2024 General Catalog Page Q8.

Spare Parts

Item Number	Clamp screw	Screw (for CNT)	Wrench (for Clamp screw)
CTPAR12H-OH	LRIS-4*12PW	SPR1/8	CLR-15S
CTPAR16H-OH	LRIS-4*12PW	SPR1/8	CLR-15S
CTPAL12H-OH	LRIS-4*12PW	SPR1/8	CLR-15S
CTPAL16H-OH	LRIS-4*12PW	SPR1/8	CLR-15S

CTDP.. series/Toolholder

CTDP-OH3 Direct connect coolant port 3-hole type CUT DUO SPLASH

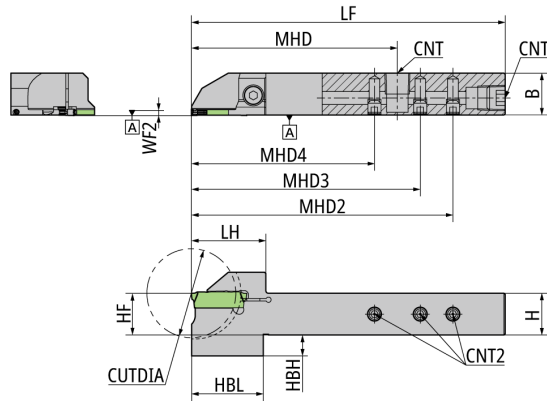

● Diagram shows right-hand tool

EDP	Item Number	Stock	Hand	CUTDIA mm	B mm	CNT	CNT2	H mm	HBH mm	HBL mm	HF mm	LF mm	LH mm	MHD mm	MHD2 mm	MHD3 mm	MHD4 mm	WF2 mm	Insert Gage	
5121835	CTDPR16-20D25-OH3	●	R	25.4	16	Rc1/8	M5	16	4.5	21	15.5	120	22	78.75	100	87.5	70	0.2	CTDP20..	-
5122551	CTDPR16-25D34A-OH3	●	R	34	16	Rc1/8	M5	16	8	27.5	15.5	120	28.5	78.8	100	87.5	70	0.2	CTDP25..	-
5121827	CTDPL16-20D25-OH3	●	L	25.4	16	Rc1/8	M5	16	4.5	21	16	120	22	78.75	100	87.5	70	0.2	CTDP20..	-
5122379	CTDPL16-25D34A-OH3	●	L	34	16	Rc1/8	M5	16	8	27.5	16	120	28.5	78.8	100	87.5	70	0.2	CTDP25..	-

For more information on the inserts, please reference 2023/2024 General Catalog Page Q8.

Spare Parts

Item Number	Clamp screw	Screw (for CNT)	Screw (for CNT2)	Wrench (for Clamp screw)	Wrench (for CNT2)
CTDPR16-20D25-OH3	LRIS-4*12	SPR1/8L	SS0505SC	LLR-25S	LW-2.5
CTDPR16-25D34A-OH3	CS0516LSH	SPR1/8L	SS0505SC	LW-3	LW-2.5
CTDPL16-20D25-OH3	LRIS-4*12	SPR1/8L	SS0505SC	LLR-25S	LW-2.5
CTDPL16-25D34A-OH3	CS0516LSH	SPR1/8L	SS0505SC	LW-3	LW-2.5

CTDP-OH2 Direct connect coolant port 1-hole type CUT DUO SPLASH

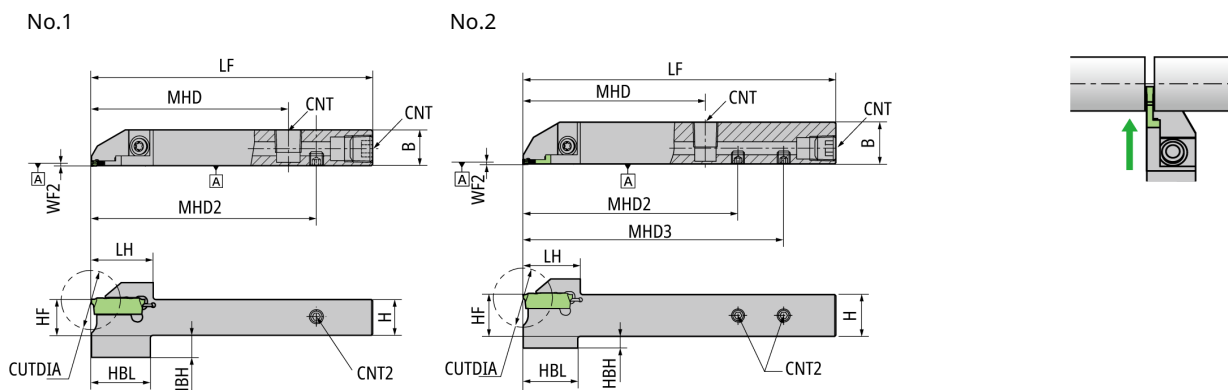

● Diagram shows right-hand tool

Figure	EDP	Item Number	Stock	Hand	CUTDIA mm	B mm	CNT	CNT2	H mm	HBH mm	HBL mm	HF mm	LF mm	LH mm	MHD mm	MHD2 mm	MHD3 mm	WF2 mm	Insert Gage	
1	5037916	CTDPR12-20D25-OH2	●	R	25.4	12	Rc1/8	M5	12	8.5	21	12	100	22	70	80	-	0.2	CTDP20..	-
2	5043856	CTDPR16-20D25-OH2	●	R	25.4	16	Rc1/8	M5	16	4.5	21	16	120	22	70	82.5	100	0.2	CTDP20..	-
1	5043930	CTDPR20-25D34A-OH2	●	R	34	20	Rc1/8	M5	20	4	27.5	20	120	28.5	75	100	-	0.2	CTDP25..	-
1	5037908	CTDPL12-20D25-OH2	●	L	25.4	12	Rc1/8	M5	12	8.5	21	12	100	22	70	80	-	0.2	CTDP20..	-
2	5043849	CTDPL16-20D25-OH2	●	L	25.4	16	Rc1/8	M5	16	4.5	21	16	120	22	70	82.5	100	0.2	CTDP20..	-
1	5043948	CTDPL20-25D34A-OH2	●	L	34	20	Rc1/8	M5	20	4	27.5	20	120	28.5	75	100	-	0.2	CTDP25..	-

For more information on the inserts, please reference 2023/2024 General Catalog Page Q8.

Spare Parts

Item Number	Clamp screw	Screw (for CNT)	Screw (for CNT2)	Wrench (for Clamp screw)	Wrench (for CNT2)
CTDPR12-20D25-OH2	LRIS-4*12	SPR1/8	SS0505SC	LLR-25S	LW-2.5
CTDPR16-20D25-OH2	LRIS-4*12	SPR1/8L	SS0505SC	LLR-25S	LW-2.5
CTDPR20-25D34A-OH2	CS0516LSH	SPR1/8	SS0505SC	LW-3	LW-2.5
CTDPL12-20D25-OH2	LRIS-4*12	SPR1/8	SS0505SC	LLR-25S	LW-2.5
CTDPL16-20D25-OH2	LRIS-4*12	SPR1/8L	SS0505SC	LLR-25S	LW-2.5
CTDPL20-25D34A-OH2	CS0516LSH	SPR1/8	SS0505SC	LW-3	LW-2.5

CTDP-OH Coolant hose connection type CUT DUO SPLASH



● Diagram shows right-hand tool

EDP	Item Number	Stock	Hand	CUTDIA mm	B mm	CNT	H mm	HBH mm	HBL mm	HF mm	LF mm	LH mm	MHD mm	WF2 mm	Insert Gage
5972567	CTDPR12-20D25-OH	●	R	25.4	12	Rc1/8	12	8.5	21	12	100	22	75	0.2	CTDP20..
5972575	CTDPR16-20D25-OH	●	R	25.4	16	Rc1/8	16	4.5	21	16	100	22	75	0.2	CTDP20..
5972989	CTDPL12-20D25-OH	●	L	25.4	12	Rc1/8	12	8.5	21	12	100	22	75	0.2	CTDP20..
5973003	CTDPL16-20D25-OH	●	L	25.4	16	Rc1/8	16	4.5	21	16	100	22	75	0.2	CTDP20..

For more information on the inserts, please reference 2023/2024 General Catalog Page Q8.

Spare Parts

Item Number	Clamp screw	Screw (for CNT)	Wrench (for Clamp screw)
CTDPR12-20D25-OH	LRIS-4*12	SPR1/8	LLR-25S
CTDPR16-20D25-OH	LRIS-4*12	SPR1/8	LLR-25S
CTDPL12-20D25-OH	LRIS-4*12	SPR1/8	LLR-25S
CTDPL16-20D25-OH	LRIS-4*12	SPR1/8	LLR-25S

Grooving/Side-Turning Operations

GTPA.. series/Toolholder

■ GTPA-OH Coolant hose connection type

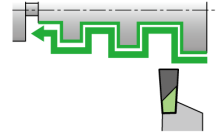
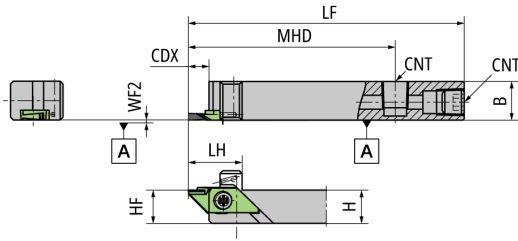

● Diagram shows right-hand tool

EDP	Item Number	Stock	Hand	B mm	CDX mm	CNT	H mm	HF mm	LF mm	LH mm	MHD mm	WF2 mm	Insert Gage
5912845	GTPAR1214H-OH	● ●	R	14	7.5	Rc1/8	12	12	100	19.5	75	0.1	GTPA..

For more information on the inserts, please reference 2023/2024 General Catalog Page Q8.

■ Spare Parts

Item Number	Clamp screw	Screw (for CNT)	Wrench (for Clamp screw)
GTPAR1214H-OH	LRIS-4*12PW	SPR1/8	CLR-15S

■ Y-GTPA-OH Coolant hose connection type Y-axis

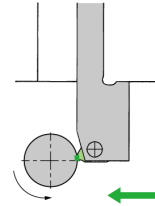
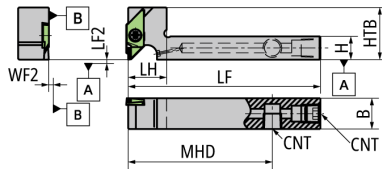

● Diagram shows right-hand tool

EDP	Item Number	Stock	Hand	B mm	CNT	H mm	HTB mm	LF mm	LF2 mm	LH mm	MHD mm	WF2 mm	Insert Gage
5930185	Y-GTPAR1014FSS-OH	● ●	R	14	M6*1	10	27	80	0	15	55	0.1	GTPA..
5911482	Y-GTPAR1216HS-OH	● ●	R	16	Rc1/8	12	27	100	0	20	75	0.1	GTPA..
5911490	Y-GTPAR1616H-OH	● ●	R	16	Rc1/8	16	27	100	0	25	75	0.1	GTPA..

For more information on the inserts, please reference 2023/2024 General Catalog Page Q8.

■ Spare Parts

Item Number	Clamp screw	Screw (for CNT)	Wrench (for Clamp screw)
Y-GTPAR1014FSS-OH	LRIS-4*12PW	SS0605SC	CLR-15S
Y-GTPAR1216HS-OH	LRIS-4*12PW	SPR1/8	CLR-15S
Y-GTPAR1616H-OH	LRIS-4*12PW	SPR1/8	CLR-15S

GTMH(X)32.. Series/Toolholder

GTTR-OH3 Direct connect coolant port 3-hole type

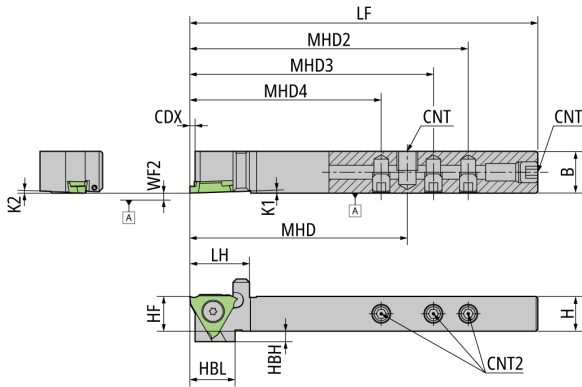

● Diagram shows right-hand tool

EDP	Item Number	Stock	Hand	B mm	CDX mm	CNT	CNT2	CW mm	H mm	HBH mm	HBL mm	HF mm	K1 °	K2 °	LF mm	LH mm	MHD mm	MHD2 mm	MHD3 mm	MHD4 mm	WF2 mm	Insert Gage	
5117734	GTTR1012H00-OH3		●	R	12	3	Rc1/8	M5	0.3-3	10	3	13	10	2	2	100	17.15	62.5	80	70	55	0	GT..32.. TBMH32..
5121330	GTTR16X00-OH3		●	R	16	3.65	Rc1/8	M5	0.3-3	16	-	-	16	2	2	120	20	78.75	100	87.5	70	0	GT..32.. TBMH32..

For more information on the inserts, please reference 2023/2024 General Catalog Page Q8.

Spare Parts

Item Number	Clamp screw	Screw (for CNT)	Screw (for CNT2)	Wrench (for Clamp screw)	Wrench (for CNT2)
GTTR1012H00-OH3	LR-S-4*10PW	SS0605SC	SS0505SC	CLR-15S	LW-2.5
GTTR16X00-OH3	LR-S-4*10PW	SPR1/8	SS0505SC	CLR-15S	LW-2.5

GTTR-OH2 Direct connect coolant port 1-hole type

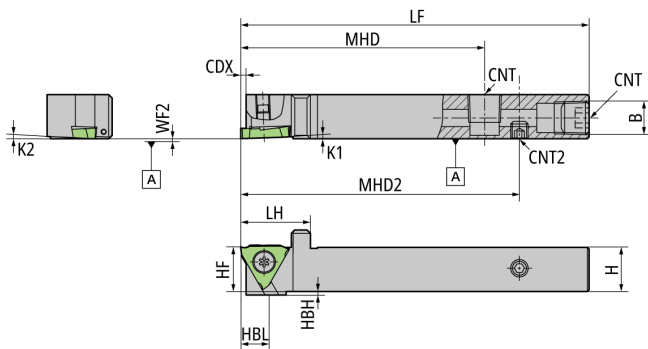

● Diagram shows right-hand tool

EDP	Item Number	Stock	Hand	B mm	CDX mm	CNT	CNT2	CW mm	H mm	HBH mm	HBL mm	HF mm	K1 °	K2 °	LF mm	LH mm	MHD mm	MHD2 mm	WF2 mm	Insert Gage	
5035381	GTTR12H00-OH2		●	R	12	1.6	Rc1/8	M5	0.3-3	12	1	13	12	2	2	100	19.5	70	80	0	GT..32.. TBMH32..
5043997	GTTR16X00-OH2		●	R	16	1.6	Rc1/8	M5	0.3-3	16	-	-	16	2	2	120	19.5	70	100	0	GT..32.. TBMH32..

For more information on the inserts, please reference 2023/2024 General Catalog Page Q8.

Spare Parts

Item Number	Clamp screw	Screw (for CNT)	Screw (for CNT2)	Wrench (for Clamp screw)	Wrench (for CNT2)
GTTR12H00-OH2	LR-S-4*10PW	SPR1/8	SS0505SC	CLR-15S	LW-2.5
GTTR16X00-OH2	LR-S-4*10PW	SPR1/8	SS0505SC	CLR-15S	LW-2.5

GTT-OH Coolant hose connection type

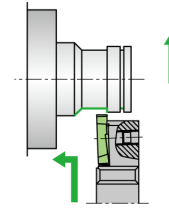
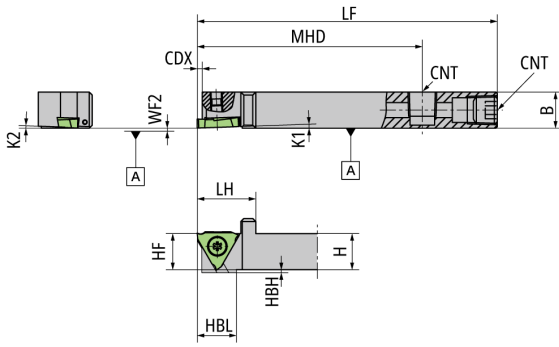

● Diagram shows right-hand tool

EDP	Item Number	Stock	Hand	B mm	CDX mm	CNT	CW mm	H mm	HBH mm	HBL mm	HF mm	K1 °	K2 °	LF mm	LH mm	MHD mm	WF2 mm	Insert Gage	
5921705	GTTR1012H00-OH	●	R	12	1.6	M6*1	0.3-3	10	1	13	10	2	2	100	19.5	70	0	GT..32..	TBMH32..
5890157	GTTR12H00-OH	●	R	12	1.6	Rc1/8	0.3-3	12	1	13	12	2	2	100	19.5	70	0	GT..32..	TBMH32..
5921713	GTTR16H00-OH	●	R	16	1.6	Rc1/8	0.3-3	16	-	-	16	2	2	100	19.5	70	0	GT..32..	TBMH32..

For more information on the inserts,
please reference 2023/2024 General Catalog Page Q8.

Spare Parts

Item Number	Clamp screw	Screw (for CNT)	Wrench (for Clamp screw)
GTTR1012H00-OH	LR-S-4*10PW	SS0605SC	CLR-15S
GTTR12H00-OH	LR-S-4*10PW	SPR1/8	CLR-15S
GTTR16H00-OH	LR-S-4*10PW	SPR1/8	CLR-15S

Y-GTT-OH Coolant hose connection type Y-axis

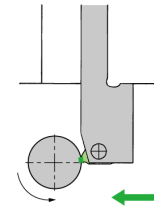
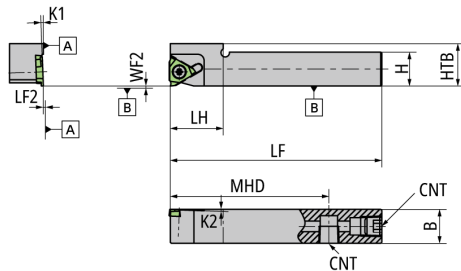

● Diagram shows right-hand tool

NOTE: Use a right-handed (R) or non-handed insert.

NOTE: There is a risk of interference with the Y-axis holder depending on the combination of the maximum workpiece diameter and machining diameter.

→O26

EDP	Item Number	Stock	Hand	B mm	CNT	H mm	HTB mm	K1 °	K2 °	LF mm	LF2 mm	LH mm	MHD mm	WF2 mm	Insert Gage	
5911466	Y-GTTR12H00S-OH	●	R	12	Rc1/8	12	20	2	2	100	0	20	75	0	GT..32..	TBMH32..
5911474	Y-GTTR16H00-OH	●	R	16	Rc1/8	16	20	2	2	100	0	25	75	0	GT..32..	TBMH32..

For more information on the inserts,
please reference 2023/2024 General Catalog Page Q8.

Spare Parts

Item Number	Clamp screw	Screw (for CNT)	Wrench (for Clamp screw)
Y-GTTR12H00S-OH	LR-S-4*10PW	SPR1/8	CLR-15S
Y-GTTR16H00-OH	LR-S-4*10PW	SPR1/8	CLR-15S

OD Single Point Threading Operations

TTP.. series/Toolholder

TTP-OH3 Direct connect coolant port 3-hole type

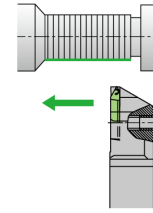
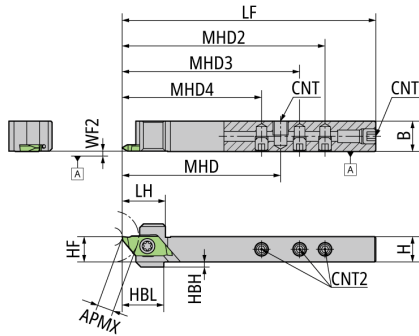

● Diagram shows right-hand tool

EDP	Item Number	Stock	Hand	APMX mm	B mm	CNT	CNT2	CUTDIA mm	H mm	HBH mm	HBL mm	HF mm	LF mm	LH mm	MHD mm	MHD2 mm	MHD3 mm	MHD4 mm	WF2 mm	Insert Gage
511775	TTPR1012H-OH3	●	R	6.5	12	M6*1	M5	16	10	2	16.5	10	100	17.15	62.5	80	70	55	0	TTP..
5117817	TTPL1012H-OH3	●	L	6.5	12	M6*1	M5	16	10	2	16.5	10	100	17.15	62.5	80	70	55	0	TTP..

For more information on the inserts, please reference 2023/2024 General Catalog Page Q8.

Spare Parts

Item Number	Clamp screw	Screw (for CNT)	Screw (for CNT2)	Wrench (for Clamp screw)	Wrench (for CNT2)
TTPR1012H-OH3	LRIS-4*12PW	SS0605SC	SS0505SC	CLR-15S	LW-2.5
TTPL1012H-OH3	LRIS-4*12PW	SS0605SC	SS0505SC	CLR-15S	LW-2.5

TTP-OH2 Direct connect coolant port 1-hole type

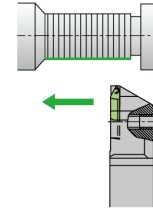
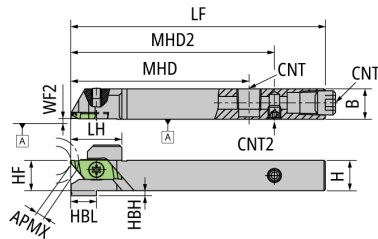

● Diagram shows right-hand tool

EDP	Item Number	Stock	Hand	APMX mm	B mm	CNT	CNT2	CUTDIA mm	H mm	HBH mm	HBL mm	HF mm	LF mm	LH mm	MHD mm	MHD2 mm	WF2 mm	Insert Gage
5061882	TTPR12H-OH2	●	R	5.5	12	Rc1/8	M5	18	12	2	10	12	100	20	70	80	0.2	TTP..
5062229	TTPR16X-OH2	●	R	5.5	16	Rc1/8	M5	18	16	-	-	16	120	19.5	70	100	0.2	TTP..
5061890	TTPL12H-OH2	●	L	5.5	12	Rc1/8	M5	18	12	2	10	12	100	20	70	80	0.2	TTP..
5062237	TTPL16X-OH2	●	L	5.5	16	Rc1/8	M5	18	16	-	-	16	120	19.5	70	100	0.2	TTP..

For more information on the inserts, please reference 2023/2024 General Catalog Page Q8.

Spare Parts

Item Number	Clamp screw	Screw (for CNT)	Screw (for CNT2)	Wrench (for Clamp screw)	Wrench (for CNT2)
TTPR12H-OH2	LRIS-4*12PW	SPR1/8	SS0505SC	CLR-15S	LW-2.5
TTPR16X-OH2	LRIS-4*12PW	SPR1/8	SS0505SC	CLR-15S	LW-2.5
TTPL12H-OH2	LRIS-4*12PW	SPR1/8	SS0505SC	CLR-15S	LW-2.5
TTPL16X-OH2	LRIS-4*12PW	SPR1/8	SS0505SC	CLR-15S	LW-2.5

MEMO



Tungaloy-NTK UK Limited

Gallan Park, Watling Street, Cannock, WS11 0XG, United Kingdom



Official Website

www.ntkcuttingtools.com/uk/



LinkedIn

www.linkedin.com/company/ntk-cutting-tools-uk



Contact us

ntkcuttingtools@ngk.co.uk

